

INSTALLATION MANUAL

15928

Level of Difficulty

Difficult

Installation difficulty levels are based on time and effort involved and may vary depending on the installer level of expertise, condition of the vehicle and proper tools and equipment.

Weight Carrying Capacity

Gross trailer weight (GTW) 16,000 lbs.

Tongue weight (TW) 1,600 lbs.

Rated up to 16,000 lbs. GTW when installing side plates mounted at a width of 42" or narrower and a drop of 9" or less

Parts List

Item	Qty	Description
1	1	Hitch center section, 44"
2	1	Side plate, driver-side, 18" drop
3	1	Side plate, passenger-side, 18" drop

⚠ WARNING

Never exceed the vehicle manufacturer's recommended towing capacity.

If metal surfaces are not completely bare, the weld will not be the required strength and may void warranty.

Product Photo



NOTICE

Visit www.curtmfg.com for a full-color copy of this instruction manual, as well as helpful videos, guides and much more!

Before you begin installation, read all instructions thoroughly.

Proper tools will improve the quality of installation and reduce the time required.

This installation requires welding. It is recommended to have two or three people during the install.

Periodic inspection of the trailer hitch should be performed to ensure all mounting hardware remains tight and structural components are secure.

To help prevent damage to the product or vehicle, refer to the specified torque specifications when securing hardware during the installation process.

SAFETY INSTRUCTIONS

Safety glasses should be worn at all times while installing this product.

Product Registration and Warranty

CURT stands behind our products with industry-leading warranties. To get copies of the product warranties, register your purchase or provide feedback, visit: warranty.curtgroup.com/surveys

ASSEMBLY

Parts List

Item	Qty	Description
1	1	Hitch center section, 44"
2	1	Side plate, driver-side, 18" drop
3	1	Side plate, passenger-side, 18" drop

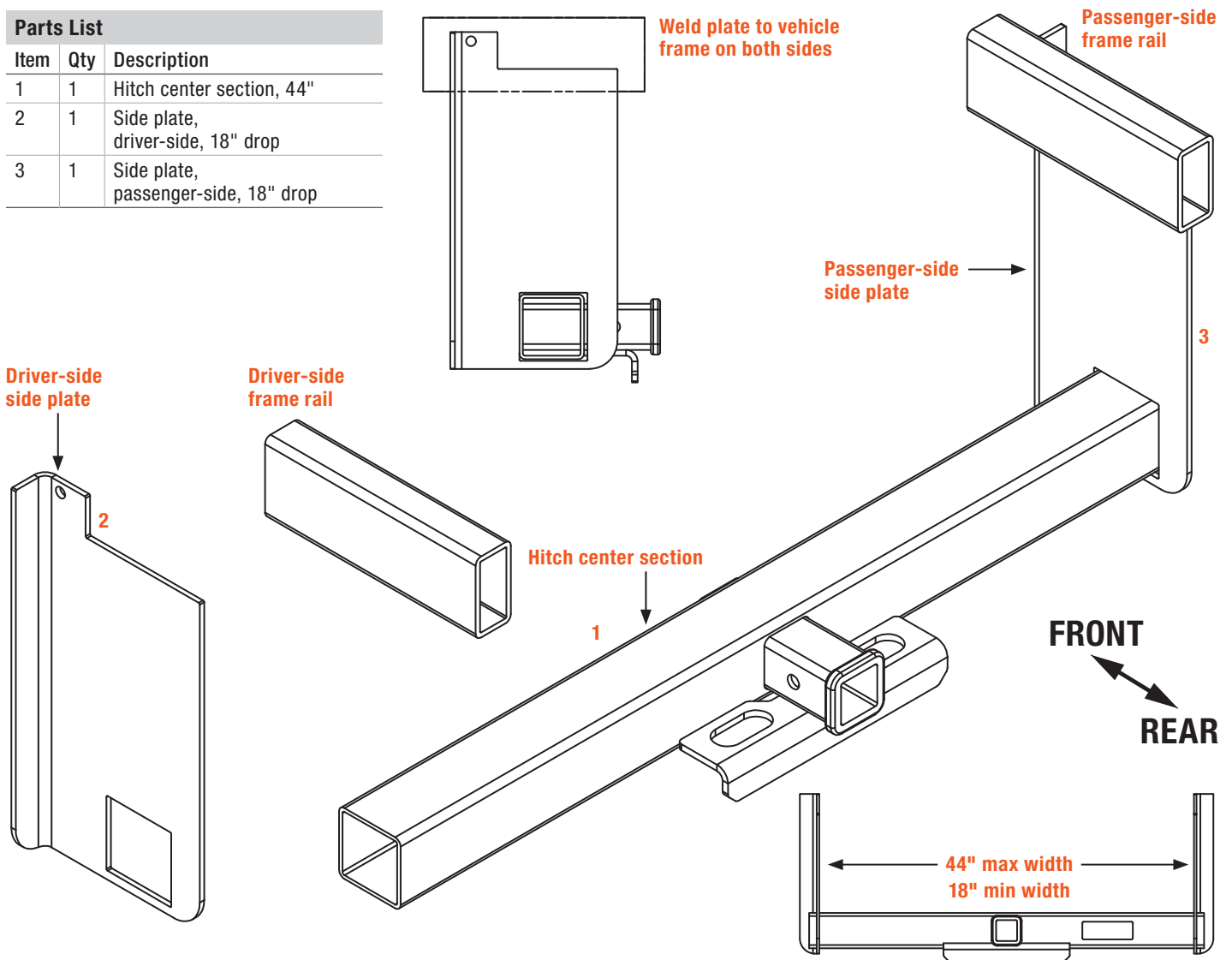

Step 1

Determine where the hitch side plates (#2,#3) will be mounted to the vehicle's frame. Clean the surface of the frame down to the bare metal in each weld location. Clean off any powder coat on the side plates where they will be mounted to the frame and hitch center section (#1). Clean all powder coat from the center section where the side plates will be welded.

⚠ WARNING

If metal surfaces are not completely bare, the weld will not be the required strength and may void warranty.

Step 2

Slide the side plates (#2,#3) onto the hitch center section (#1) and raise it into position to be welded. Secure or clamp the side plates into position on the frame. Center the hitch center section between the side plates.

Step 3

Weld the side plates (#2,#3) to the frame of the vehicle and hitch center section (#1) to AWS welding standards. Trim off any excess center section beyond the side plates as needed.

TOWING BASICS & SAFETY INFORMATION

For information on safely towing your trailer, visit curtmfg.com/understanding-towing.